

 **SGM**[®] SIXPACK

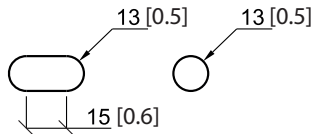

SixPack dimensions

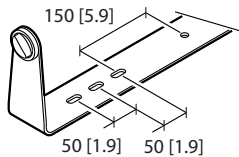
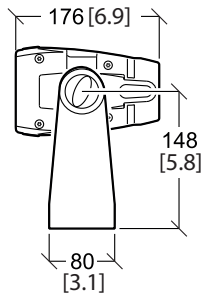
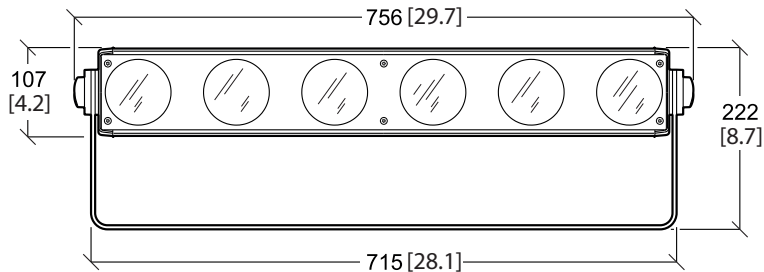

*Measurements in millimetres
and inches (in brackets).
Drawing not to scale.*

SIXPACK USER MANUAL

© 2015 SGM®. Information subject to change without notice. SGM and all affiliated companies disclaim liability for any injury, damage, direct or indirect loss, consequential or economic loss or any other loss occasioned by the use of, inability to use or reliance on the information contained in this manual.

The SGM logo, the SGM name and all other trademarks in this document pertaining to services or products by SGM or its affiliates and subsidiaries are trademarks owned or licensed by SGM or its affiliates or subsidiaries.

The original edition of this document is in English. All other language editions are translations of the original edition.

This edition applies to firmware version 1.60 or later.

Ver. E

Contents

SixPack dimensions	2
Safety information	7
Overview	10
Parts identification and terminology	11
Preparing for installation	12
Installing the SixPack	13
<i>Using the stand bracket</i>	13
Installing fixtures at elevation in an array	15
<i>Planning the layout of fixtures in an array</i>	16
<i>Attaching snap-lock brackets</i>	17
<i>Connecting vertically-oriented SixPacks into an array thread</i>	18
<i>Connecting a stack of horizontally-oriented SixPacks into an array thread</i>	20
<i>Connecting arrays together into a larger matrix</i>	21
Connecting AC Power	22
Configuring the fixture	24
<i>Configuring the fixture using an Android telephone via RFID</i>	24
<i>Full Color Calibration and Color Temperature Correction</i>	25

Setting a static color manually	26
Using stand-alone operation	27
Connecting to a DMX control device	28
<i>About DMX</i>	29
<i>Setting the DMX address</i>	29
<i>Setting the DMX mode</i>	30
Fixture personality settings	31
<i>Setting the dimming curve</i>	31
<i>Temperature dimming mode options</i>	31
<i>Reversing the fixture pixel order</i>	31
<i>Flipping the OLED display</i>	31
<i>Setting the OLED display saver</i>	32
<i>RDM protocol communications address</i>	32
Service	33
<i>Upgrading the firmware</i>	33
<i>Cleaning</i>	33

DMX protocols	34
6 Channel Mode - Halogen Dimmer Emulation	34
7 Channel Mode - Effects, Intensity & RGBA control	35
18 Channel Mode - RGB with automatic Amber.....	37
22 Channel Mode - Effects, Intensity, Halogen Dimmer Emulation, RGB & automatic Amber	39
24 Channel Mode - Individual RGBA control.....	42
28 Channel Mode - Effects, Intensity, Halogen Dimmer Emulation & individual RGBA control	44
48 Channel Mode - 8-bit/16-bit individual RGBA control	48
53 Channel Mode - Effects, Intensity, Halogen Dimmer Emulation & 8-bit/16-bit individual RGBA control	52
Control menu	57
Fixtures and accessories	63
Included items.....	63
Ordering information.....	63
User's notes	65

Safety information



WARNING! Read the safety precautions in this section before unpacking, installing, powering or operating this product.

The SixPack is a multi-environmental fixture with an IP-rating of 65, intended for professional use only. It is not suitable for household use. **Impropre a l'usage domestique.**

Review the following safety precautions carefully before installing or operating the fixture. This fixture must be installed in accordance with the applicable installation code by a person familiar with the construction and operation of the fixture and the hazards involved. **Ce produit doit être installé selon le code d'installation pertinent, par une personne qui connaît bien le produit et son fonctionnement ainsi que les risques inhérent.**

Preventing electric shock



WARNING! Risk of electric shock.

- Always power off/unplug the fixture before removing any covers.
- Ensure that the power is turned off when connecting the fixture to the AC mains supply.
- Ensure that the fixture is electrically connected to earth (ground).
- Do not apply power if the fixture is in any way damaged.
- Do not immerse the fixture in water or liquid.

Preventing burns and fire



WARNING! Take measures to prevent burns and fire.

- Install in a location that prevents accidental contact with the fixture.
- Install only in a well-ventilated space.
- Install at least 0.3 m (12 in.) away from objects to be illuminated.
- Install only in accordance with applicable building codes.
- Do not paint, cover or modify the fixture.
- Do not filter or mask the light.
- Keep all flammable materials away from the fixture.
- Allow the fixture to cool for 15 minutes after operation, before touching it.

CAUTION: *Exterior surface temperature after 5 min. operation = 35°C (91°F). Steady state = 70°C (182°F).*

Avoid personal injury



WARNING! *Take measure to prevent personal injury.*

- Do not look directly at the light source from close range.
- Take precautions to prevent injury due to falls when working at height.
- For permanent installation, ensure that the fixture is securely fastened to a load-bearing surface with suitable corrosion-resistant hardware.
- For temporary installation with brackets, ensure that they are fastened properly and secured with a suitable safety cable. The cable must be approved for a safe working load (SWL) of 10 times the weight of the fixture, and it must have a minimum gauge of 3 mm.

Overview

The SixPack is a unique pixel array based on the popular blinder — but by replacing the traditional halogen with RGBA LED source it can achieve much more.

The fixture combines six outputs of powerful 40W color mixing with built-in electronics, and individual DMX control over each lamp, allowing the Lighting Designer to paint light canvasses displaying animated text or programmed patterns.

The SixPack will not only control the color but the LEDs will also emulate the decay of the old halogen lamp, while the housing itself is trapezoidal-shaped so that multiples can be hung in vertical or horizontal matrixes or clustered into an array using the easy install rigging system.

The fixture offers built-in dimming, RGBA color mixing, color temperature correction, DMX, wireless configuration via RFID, and a lamp life expectancy of 50,000 hours*.

This manual covers installation, use and maintenance of the SixPack. All documentation is also available from the SGM web-site: <http://www.sgmlight.com>

* At 70% of luminous output under the manufacturer's test conditions.

Parts identification and terminology

- A Tilt locks
- B DMX in
- C Fuse holder
- D Power in
- E Safety cable eyelet
- F OLED display panel and control panel
- G Bracket/stand
- H RFID interface
- I DMX out cable
- J Pressure relief valve
- K Power out cable

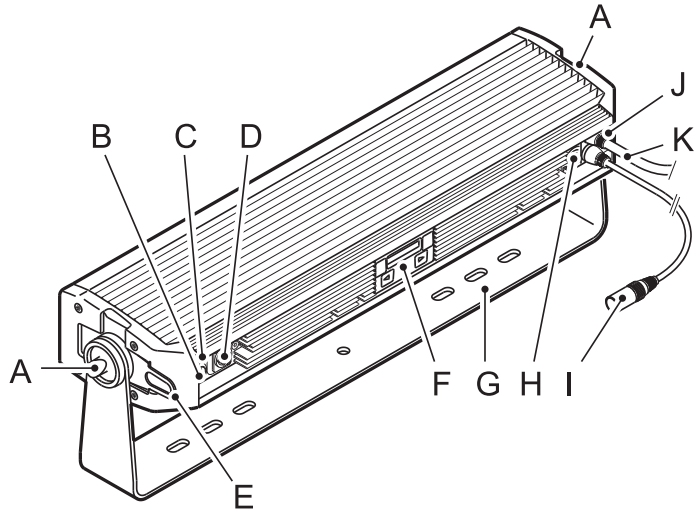

Preparing for installation

Unpack the fixture and inspect it to ensure that it has not been damaged during transport.

The SixPack is shipped with this user guide, a stand bracket, a vertical-array top mounting bracket, two snap-lock brackets, a Neutrik powerCON TRUE1 power cable and two locking pins with cotter pins. The fixture is IP65-rated, and is designed for use in wet locations. This means that it is protected from:

- Dust, to the degree that dust cannot enter the fixture in sufficient quantities as to interfere with its operation.
- Low-pressure water jets from any direction.

When selecting a location for the fixture, ensure that:

- It is situated away from public thoroughfares and protected from contact with people.
- It is not immersed in water or exposed to high-pressure water jets.
- It has adequate ventilation.

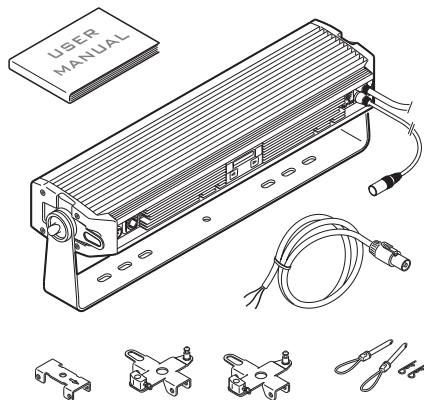

Installing the SixPack

The SixPack may be installed in any orientation, but if installed horizontally with a downward beam-angle, water can potentially pool in grooves and near the power input/output cables. Under normal operation the moisture will evaporate. However, in locations with high rainfall, you may wish to fabricate a rain shield above the fixture, or modify the position and orientation of the fixture to minimize pooling.

Using the stand bracket

The fixture is supplied with a stand bracket that can be bolted to a surface using M12 hardware, or used to fly a single fixture at elevation using clamps or similar. The bracket is not designed to support the weight of more than one fixture. The angle of the fixture can be adjusted using the tilt locks at either end of the fixture.

For permanent installation on the ground, fasten the fixture securely through the holes in the bracket/stand with minimum two 12 mm (1/2 in.) corrosion-resistant mechanical fasteners suitable for the location.

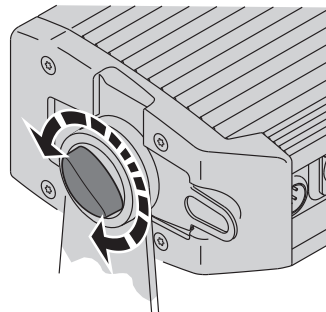

Fasten a safety cable (not shown) between the support structure and the attachment point on the fixture. The safety cable must be able to bear at least 10 times the weight of the fixture and have a min. safety wire gauge of 3 mm.

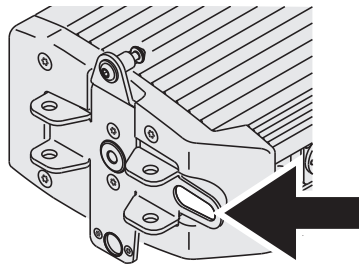
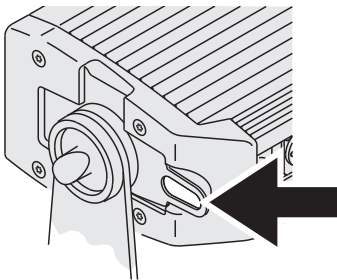

WARNING! Always secure an elevated SixPack with a safety cable as backup.

Installing fixtures at elevation in an array



WARNING! Do not connect more than eight SixPacks together in a single array.

Using the supplied snap-lock brackets, horizontally (flat) or vertically (up-right) aligned SixPack fixtures can be connected into arrays. The supplied hardware is able to bear the weight of up to eight SixPack fixtures.

Arrays can be flat (rigid) or curved, as fixtures that are connected using the snap-lock connectors can be curved outwards at an angle of 29° . Always ensure that each fixture in an array has a safety cable connecting it to the load bearing structure, and not simply to another fixture in the array.

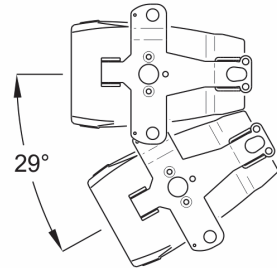

Planning the layout of fixtures in an array

Daisy-chaining is useful because it reduces the amount of cabling required. For ease of connecting the fixtures in a power/DMX daisy-chain and to ensure a tidy uncluttered rig, we recommend that the orientation of fixtures in an array is carefully planned to enable each fixture to be connected to the next using the built-in 0.5 m (20 in.) cables.

In some cases, because of the cable lengths, this will require some fixtures to be flipped over in relation to their immediately adjacent fixtures. To ensure consistency of control, these devices should have their pixel orders reversed using the "Settings→Reverse Pixel Order→Reversed" menu (see "Reversing the fixture pixel order" on page 31). To flip the display, see "Flipping the OLED display" on page 31.

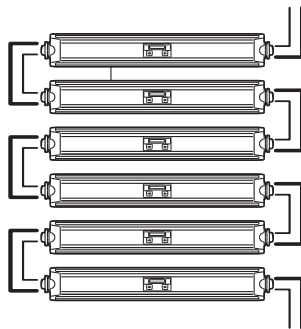

Attaching snap-lock brackets

Two snap lock brackets are supplied with each fixture and these are used to connect fixtures together in arrays.

To remove the stand bracket and mount the snap-lock brackets:

- 1 Unscrew the tilt locks on each side of the fixture and detach the stand.
- 2 Remove the two Torx 25 screws that hold the safety cable eyelet in place and remove the eyelet.
- 3 Attach the snap lock brackets as shown, so that the male and female components are placed at opposite ends.

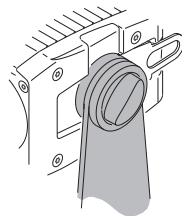

1

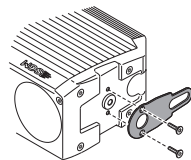

2

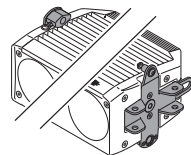

3

Connecting vertically-oriented SixPacks into an array thread

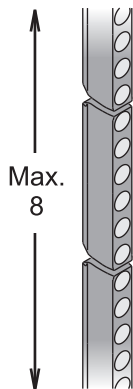

Up to eight vertically-aligned (upright) SixPacks can be connected using the supplied locking pins inserted through the eye holes on the snap-lock brackets.

The fixture at the top of a vertically-aligned array thread must always be flown using a vertical-array top mounting bracket (supplied with the fixture) that is attached to a G-clamp or another suitable mounting hardware, and secured to a structure dimensioned to bear the load. We recommend that this top fixture be oriented to enable it to be daisy chained to its adjacent fixture using the built-in DMX and power cables (see "Planning the layout of fixtures in an array" on page 16)

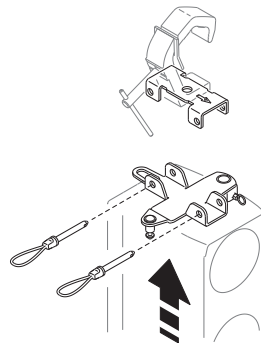

If you want a curved array along the vertical plane, then only one locking pin is required at each end. To achieve a flat, rigid array, insert locking pins in both holes.

To connect one vertically-oriented SixPack fixture to another:

- 1 Lift a SixPack into position under the other so that the eye holes on each fixture are aligned. Orient the fixture so that the built-in DMX and power patch cables and connectors are able to reach, or be reached, by adjacent fixtures in a daisy chain.
- 2 Insert one (for curved array) or two (for flat array) of the supplied locking pins into the holes and secure them using the cotter pins.

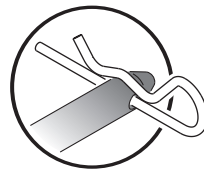
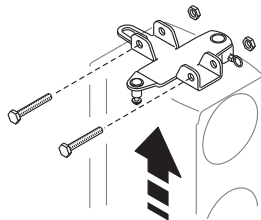
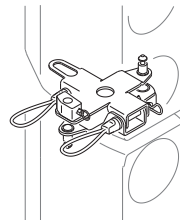
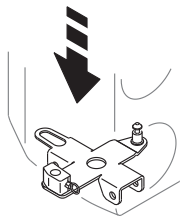

Connecting a stack of horizontally-oriented SixPacks into an array thread

Up to eight horizontally-aligned SixPacks can be connected using the snap-lock connectors on the snap-lock brackets.

The fixture at the top of a horizontally-aligned array thread must always be flown using suitable mounting hardware attached to the snap-lock bracket eye bolts and secured using appropriate mounting hardware, such as G-clamps, to a structure dimensioned to bear the load. We recommend that this top fixture be oriented to enable it to be daisy-chained to one of its adjacent fixtures using the 0.5 m (20 in.) built-in DMX and power cables.

To connect one SixPack fixture to another:

- 1 Lift a SixPack into position under the other. Depending on how you plan to daisy-chain power and DMX cables between fixtures, you might choose to mount every second fixture upside down so that the built-in DMX and power patch cables can reach the next fixture (see “Planning the layout of fixtures in an array” on page 16).
- 2 Insert one end of the fixture into the snap-lock bracket of the other fixture and then insert the opposite end of the fixture into the snap-lock bracket of the other fixture and click into place.

Note that fixtures connected using the snap-lock connectors can be curved outwards at an angle of 29°.

To detach one fixture from another, release the lock by pulling the small ring at the female socket. Then, detach that end and pull the opposite end free.

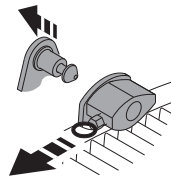
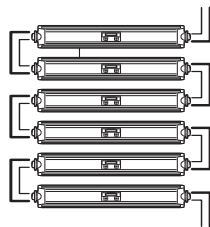
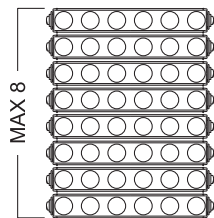

Connecting arrays together into a larger matrix

No single fixture may be loaded with the weight of more than seven other fixtures in an array. Array threads can be connected to other array threads, but each array thread must have its own secure connection to a load bearing structure, and not have its weight supported by another array thread. We recommend that adjacent fixtures be oriented to enable them to be daisy-chained together using the 0.5 m (20 in.) built-in DMX and power cables. (see “Planning the layout of fixtures in an array” on page 16). Hardware connections between one array thread and another are for the purpose of controlling pitch (angle) or to obtain rigidity.

To connect any two vertical-array threads (see “Connecting vertically-oriented SixPacks into an array thread” on page 18) along the:

- Horizontal plane, side-by-side, use the snap-lock connectors on the snap-lock brackets.
- Vertical plane, one above or below the other, use the supplied locking pins, inserted through the holes in the brackets at both ends of each fixture, and secured using the cotter pins. Use two locking pins between each fixture to achieve a rigid flat structure, or a single locking pin between each fixture to adjust the pitch angle.

To connect any two horizontal-array threads (see “Connecting a stack of horizontally-oriented SixPacks into an array thread” on page 20) along the:

- Horizontal plane, side-by-side, use the supplied locking pins, inserted through the holes in the brackets at both ends of each fixture, and secured using the cotter pins. Use two locking pins between each fixture to achieve a rigid flat structure, or a single locking pin between each fixture to adjust the pitch angle.
- Vertical plane, one above or below the other, use the snap-lock connectors on the brackets.



These connection methods must only be used to control the pitch (angle) along the horizontal axis, **not as a form for load bearing.**

Connecting AC Power

The SixPack can operate on any 100-240V 50/60 Hz AC mains power supply. Connect the fixture to power using a cable with a Neutrik powerCON TRUE1 connector (supplied with the fixture). The fixture can feed power to another fixture in a daisy chain using the built-in 0.5 m (20 in.) power-out cable.

For permanent installation, have a qualified electrician wire the mains cable directly to a suitable branch circuit. The junction's IP-rating must be suitable for the location.

The power cable color coding is given below:

Wire	Color	Symbol	Conductor
	Black	L	live
	White	N	neutral
	Green	⏏ or ⏚	ground (earth)

Fuse, T5A

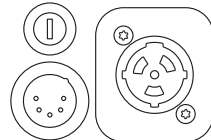

DMX In

Power In

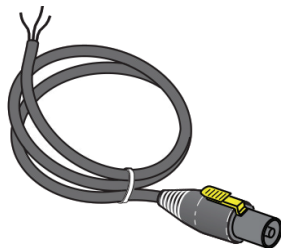

Due to the high level of in-rush current when the fixtures are powered on, ensure that no more than:

- 4 SixPack fixtures-connected through the same type C, 10A circuit breaker-are powered on at the same time.
- 9 SixPack fixtures-connected through the same type C, 16A circuit breaker-are powered on at the same time.

For assistance with alternative configurations, contact your SGM representative.

The SixPack must be grounded/earthed and be able to be isolated from AC power. The AC power supply must incorporate a fuse or circuit breaker for fault protection.

After connecting the SixPack to power, run the on-board test, using the “Test→Automated test” menu, to ensure that the fixture and each LED are functioning correctly (See “Control menu” on page 57).

CAUTION: *Do not open the fixture to replace the supplied power cable, or connect the fixture to an electrical dimmer system, as this can damage it.*

Configuring the fixture

Set up the fixture using the control panel and OLED display at the rear of the fixture:

- A - Escape button
- B - OLED display
- C - Enter button
- D - Left arrow button
- E - Right arrow button

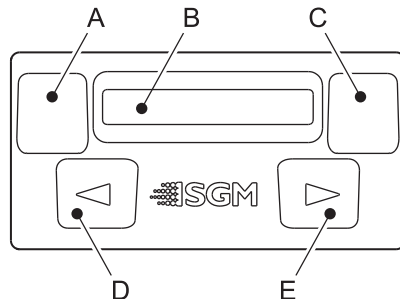

Navigate the menus and options using the arrow buttons and select items using the Enter button. The options available are listed in “Control menu” on page 57. If the device is mounted upside down, you can flip the display (and the buttons) by holding the Escape and Enter button down at the same time. Fixtures that have their pixel order for DMX control reversed show an “R” in the display.

Configuring the fixture using an Android telephone via RFID

As an alternative to connecting the fixture to power and using the control panel, one or more SixPack fixtures can also be configured wirelessly, via RFID, using the SGM Tool app (available from the Google Play Store) installed on an Android smart phone that has NFC support (ISO 15693 and ISO 18000-3 mode 1 compatible, operating on 13.56 MHz ± 7 k Hz carrier frequency).

Full Color Calibration and Color Temperature Correction

Channel Modes 7, 8, 22, 28 & 53: Lets you choose white-calibrated color (3200K - 6500K default) via the CTC channel. When you adjust the white color temperature, all RGB or RGBA channels (if available) must be set to 100%.

Channel Modes 18, 24 & 48: Features full color calibration (irrespective of current color setting) when you mix 2 or 3 colors to ensure uniform color between products. Adjusting 1 color does not activate full color calibration.

Channel Modes 7, 8, 22, 28 & 53	Channel Modes 18, 24 & 48
Choose white-calibrated color (3200K - 6500K default) via the CTC channel. NOTE: When you adjust the white color temperature, all RGB or RGBA channels (if available) must be set to 100%.	Full Color Calibration

Setting a static color manually

The fixture can be configured to display a predefined and static color using the “Manual→Quick color” menus (see “Control menu” on page 57). Note that whenever the “Manual→Quick color” settings are changed, the fixture will be set by default to automatically start in quick color mode whenever it is powered on. This can be reset using the “Settings→Startup mode→Select startup mode” (see “Control menu” on page 57).

Using stand-alone operation

Stand-alone operation is where the fixture is not connected to a control device, but is preprogrammed with a series of up to 24 scenes, that play continuously in a loop. Up to three stand-alone programs can be defined and run from the menus, and one of the programs can be set to run by default whenever the fixture is started.

Each of the three available stand-alone programs contains 24 user-definable scenes, each scene with its own RGBA and shutter settings. Each scene has a definable fade-in time, for the transition from one color to the next, and a wait (static) time, each of up to 999 minutes and 59 seconds in duration. To define a stand-alone program, use the “Manual→Editor” menus (see “Control menu” on page 57).

Stand-alone mode at fixture startup is enabled using the “Settings→Startup mode→Select startup mode→Standalone” menu. The program to be run is selected using “Settings→Startup mode→Startup program” menu (see “Control menu” on page 57) for a description of the menus). The chosen program will run its length cyclically whenever the fixture is powered on.

A program can be run at any time by selecting it using the “Manal→Run program” menu.

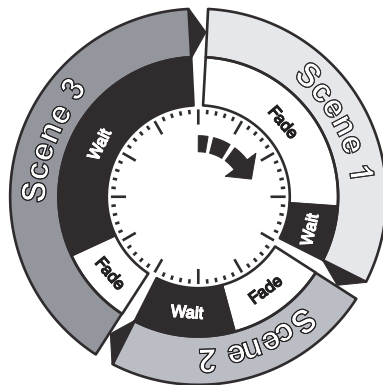

Connecting to a DMX control device

The SixPack complies with the Digital MultipleX (DMX) communications protocol. The fixture is controlled using a DMX control device and must be connected to the data link using a DMX cable with a 5-pin XLR DMX connector.

Connect the DMX in socket and out socket to the DMX data link. The fixture can feed control signals to another fixture in a daisy chain using the built-in 0.5 m (20 in.) DMX-out cable.

Use only IP-rated XLR connectors when using the fixture outdoors.

Terminate the last fixture in the data link by connecting a 5-pin XLR DMX terminator to its DMX-out socket. A terminator can be purchased from your cable or lighting supplier, or made by soldering a 120-ohm resistor between pins 2 and 3 in a 5-pin XLR DMX connector.

Pin	Signal
1	Signal common
2	Data -
3	Data +
4	Not used
5	Not used

About DMX

The SixPack is controlled using signals sent by a DMX controller on a number of channels (6, 7, 24, 28 or 48 depending on the DMX mode that has been set). The first channel used to receive data from a DMX control device is known as the DMX address. Each Six Pack must have a DMX address set. For example, if a SixPack has a DMX address of 10 and it is in 7-channel DMX mode, then it uses channels 10, 11, 12, 13, 14, 15 and 16. The following fixture in the DMX chain could then be set to a DMX address of 17. If two or more DMX fixtures of the same type have the same DMX address, then they will mimic each other's behavior. Incorrect settings will result in unpredictable responses to the lighting controller.

Setting the DMX address

After powering the SixPack on, the display shows the currently selected DMX address and other information.

- A** - Operational mode
- B** - DMX address
- C** - Data indicator
- D** - Data protocol

To change the address setting, press the left arrow button to increase the address, or the right arrow button to decrease the setting. When the desired address is displayed, press Enter to save the setting. For your convenience, the suggested DMX address of the next fixture is displayed to the right. Note that channel spacing is determined by the DMX mode.

See the “DMX protocols” on page 34 for specific DMX control values, and “Configuring the fixture” on page 24 for DMX connection requirements.

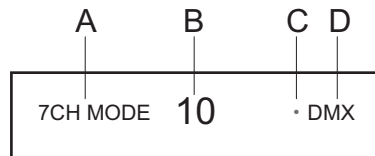

Setting the DMX mode

Using the “DMX mode” menu available from the control panel, specify the DMX mode that provides the fixture controls you require:

DMX modes	Function
6	Halogen dimmer emulation.
7	Effects, Intensity & RGBA control
18	RGB with automatic Amber
22	Effects, Intensity, Halogen Dimmer Emulation, RGB & automatic Amber
24	Individual RGBA control
28	Effects, Intensity, Halogen Dimmer Emulation & individual RGBA control
48	8-bit/16-bit Individual RGBA control
53	Effects, Intensity, Halogen Dimmer Emulation & 8-bit/16-bit individual RGBA control

Fixture personality settings

Setting the dimming curve

The setting of the dimming curve will determine the fixture's behavior, when changing the light intensity between 0% - 100%. Linear control provides uniform adjustment throughout the control action, whereas gamma corrected dimming provides finer control at low light levels, where the eye is more sensitive to change. By default, the SixPack uses gamma corrected dimming. For uniform response, set all fixtures to the same dimming curve. To set the desired dimming curve, use the "Settings→Dimming curve" menu.

Temperature dimming mode options

As the fixture warms up, the color of the light changes slightly. By default, the fixture will dim the colors according to the temperature of the fixture, in order to keep a consistent color output. This function can be disabled by selecting the 'Max Power' option available under the Temperature Dim Mode from the Settings menu (see "Control menu" on page 57).

Reversing the fixture pixel order

This option can be used for a fixture in an array, in order to align the order that pixels are addressed from DMX control. This function is commonly used where fixtures are installed upside-down relative to their peer fixtures, for the purpose of daisy-chaining fixtures together using the integrated cabling. Fixtures that have their pixel order reversed show an "R" in the display. To reverse the pixel order, use the "Settings→Reverse Pixel Order→Reversed" menu (see "Control menu" on page 57) or press the left and right arrow buttons at the same time.

Flipping the OLED display

If the fixture is installed hanging upside down, it might be useful to flip the display so that it is easier to read. To flip the display, use the "Settings→Flip display" menu, or press the up and down buttons on the control panel at the same time.

Setting the OLED display saver

By default the OLED display dims down after a short period when the control panel is not in use, but it can also be set to turn off completely. Pressing any key will always turn on the display or restore it to normal brightness. To change the display saver, use the “Settings→Display saver” menu.

NOTE: To avoid the risk of display deterioration caused by long term use in permanent installations, it is recommended to use the “Display saver”→“Display off” setting.

RDM protocol communications address

The RDM address used for Remote Device Management can be seen using the control menus (See “Control menu” on page 57).

Service

There are no user-serviceable components in the fixture. Do not open the SixPack, as doing so is likely to damage the ingress protection. Consult your SGM dealer if the fixture operates abnormally, is defective or otherwise in need of service or repair.

The mains fuse can be found under the cover next to the power inlet socket. The fuse cover can be opened using a slotted screwdriver.

Upgrading the firmware

The firmware installed on the fixture can be identified using the “Info→Firmware version” menu. We recommend that you keep your fixture’s firmware up-to-date. Visit <http://www.sgmlight.com> to download the latest firmware. To perform firmware updates, you need a Windows-based personal computer and a SGM USB 5-Pin-XLR upload cable (available from your SGM distributor).

Fuse, T5A

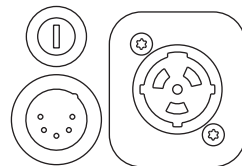

DMX In

Power In

Cleaning

To maintain optimal performance, regular cleaning is essential. Cleaning schedules will vary depending on the operating environment, and the installation should therefore be checked at frequent intervals within the first few weeks of operation to see whether cleaning is necessary. This procedure will allow you to assess cleaning requirements in your particular situation. If in doubt, consult your SGM dealer for a suitable maintenance schedule.

Clean the SixPack using a soft cloth dampened with a solution of water and a mild detergent. Do not use products that contain solvents, abrasives or caustic agents for cleaning, as they can cause damage to both hardware, cables and connectors.

DMX protocols

Configuring DMX is described in “Connecting to a DMX control device” on page 28.

6 Channel Mode - Halogen Dimmer Emulation

Channel	Name	DMX value		DMX percentage		Description	Info	Default DMX value	Fader type
1	Pixel 1	0	255	0%	100%	Emulation	Halogen	0%	Fade
2	Pixel 2	0	255	0%	100%	Emulation	Halogen		
3	Pixel 3	0	255	0%	100%	Emulation	Halogen		
4	Pixel 4	0	255	0%	100%	Emulation	Halogen		
5	Pixel 5	0	255	0%	100%	Emulation	Halogen		
6	Pixel 6	0	255	0%	100%	Emulation	Halogen		

7 Channel Mode - Effects, Intensity & RGBA control

Channel	Name	DMX value		DMX percentage		Description	Info	Default DMX value	Fader type
1	Shutter	0	7	0,0%	2,7%	Closed		10 (3,9%)	Snap
		8	15	3,1%	5,9%	Open			
		16	151	6,3%	59,2%	Strobe	Fast > Slow		
		152	175	59,6%	68,6%	Pulse - Open	Slow > Fast		
		176	199	69,0%	78,0%	Pulse - Close	Slow > Fast		
		200	244	78,4%	95,7%	Strobe - Random	Slow > Fast		
		245	255	96,1%	100,0%	Open			
2	Intensity	0	255	0%	100%	No Light > Maximum light		0 (0%)	Fade
3	RED	0	255	0%	100%	No RED > Maximum RED	All pixels		
4	GREEN	0	255	0%	100%	No GREEN > Maximum GREEN	All pixels	0 (0%)	Fade
5	BLUE	0	255	0%	100%	No BLUE > Maximum BLUE	All pixels		
6	AMBER	0	255	0%	100%	No AMBER > Maximum AMBER	All pixels		

Channel	Name	DMX value	DMX percentage	Description	Info	Default DMX value	Fader type
7	CTC	0 9	- -	No function		-	-
		10 255	0% 100%	Color Temperature (3200K-6500K)	Only when RGBA is at 100%	0 (0%)	Fade

18 Channel Mode - RGB with automatic Amber

Channel	Name	DMX value		DMX percentage		Description	Info	Default DMX value	Fader type
1	RED	0	255	0%	100%	No RED > Maximum RED	Pixel 1	0 (0%)	Fade
2	GREEN	0	255	0%	100%	No GREEN > Maximum GREEN	Pixel 1		
3	BLUE	0	255	0%	100%	No BLUE > Maximum BLUE	Pixel 1		
4	RED	0	255	0%	100%	No RED > Maximum RED	Pixel 2		
5	GREEN	0	255	0%	100%	No GREEN > Maximum GREEN	Pixel 2		
6	BLUE	0	255	0%	100%	No BLUE > Maximum BLUE	Pixel 2		
7	RED	0	255	0%	100%	No RED > Maximum RED	Pixel 3		
8	GREEN	0	255	0%	100%	No GREEN > Maximum GREEN	Pixel 3		
9	BLUE	0	255	0%	100%	No BLUE > Maximum BLUE	Pixel 3		
10	RED	0	255	0%	100%	No RED > Maximum RED	Pixel 4		
11	GREEN	0	255	0%	100%	No GREEN > Maximum GREEN	Pixel 4		
12	BLUE	0	255	0%	100%	No BLUE > Maximum BLUE	Pixel 4		

Channel	Name	DMX value		DMX percentage		Description	Info	Default DMX value	Fader type
13	RED	0	255	0%	100%	No RED > Maximum RED	Pixel 5	0 (0%)	Fade
14	GREEN	0	255	0%	100%	No GREEN > Maximum GREEN	Pixel 5		
15	BLUE	0	255	0%	100%	No BLUE > Maximum BLUE	Pixel 5		
16	RED	0	255	0%	100%	No RED > Maximum RED	Pixel 6		
17	GREEN	0	255	0%	100%	No GREEN > Maximum GREEN	Pixel 6		
18	BLUE	0	255	0%	100%	No BLUE > Maximum BLUE	Pixel 6		

22 Channel Mode - Effects, Intensity, Halogen Dimmer Emulation, RGB & automatic Amber

Channel	Name	DMX value	DMX percentage	Description	Info	Default DMX value	Fader type
1	Shutter	0 7	0,0% 2,7%	Closed		10 (3,9%)	Snap
		8 15	3,1% 5,9%	Open			
		16 151	6,3% 59,2%	Strobe	Fast > Slow		
		152 175	59,6% 68,6%	Pulse - Open	Slow > Fast		
		176 199	69,0% 78,0%	Pulse - Close	Slow > Fast		
		200 244	78,4% 95,7%	Strobe - Random	Slow > Fast		
		245 255	96,1% 100,0%	Open			
2	Intensity	0 255	0% 100%	No Light > Maximum light		0 (0%)	Fade
3	Halogen Dimmer Emulation	0 7	0% 2,7%	Disable		0 (0%)	Fade
		8 15	3,1% 5,9%	Emulate Halogen dimming			
		16 21	6,3% 8,2%	Emulate Halogen dimming			
		22 255	8,6% 100%	No Function			

Channel	Name	DMX value	DMX percentage	Description	Info	Default DMX value	Fader type
4	CTC	0 9	- -	No function		-	-
		10 255	0% 100%	Color Temperature (3200K-6500K)	Only when RGBA is at 100%	0 (0%)	Fade
5	RED	0 255	0% 100%	No RED > Maximum RED	Pixel 1		
6	GREEN	0 255	0% 100%	No GREEN > Maximum GREEN	Pixel 1	0 (0%)	Fade
7	BLUE	0 255	0% 100%	No BLUE > Maximum BLUE	Pixel 1		
8	RED	0 255	0% 100%	No RED > Maximum RED	Pixel 2		
9	GREEN	0 255	0% 100%	No GREEN > Maximum GREEN	Pixel 2		
10	BLUE	0 255	0% 100%	No BLUE >Maximum BLUE	Pixel 2		
11	RED	0 255	0% 100%	No RED > Maximum RED	Pixel 3		
12	GREEN	0 255	0% 100%	No GREEN > Maximum GREEN	Pixel 3		

Channel	Name	DMX value	DMX percentage	Description	Info	Default DMX value	Fader type
13	BLUE	0 255	0% 100%	No BLUE > Maximum BLUE	Pixel 3	0 (0%)	Fade
14	RED	0 255	0% 100%	No RED > Maximum RED	Pixel 4		
15	GREEN	0 255	0% 100%	No GREEN > Maximum GREEN	Pixel 4		
16	BLUE	0 255	0% 100%	No BLUE > Maximum BLUE	Pixel 4		
17	RED	0 255	0% 100%	No RED > Maximum RED	Pixel 5		
18	GREEN	0 255	0% 100%	No GREEN > Maximum GREEN	Pixel 5		
19	BLUE	0 255	0% 100%	No BLUE > Maximum BLUE	Pixel 5	0 (0%)	Fade
20	RED	0 255	0% 100%	No RED >Maximum RED	Pixel 6		
21	GREEN	0 255	0% 100%	No GREEN > Maximum GREEN	Pixel 6		
22	BLUE	0 255	0% 100%	No BLUE > Maximum BLUE	Pixel 6		

24 Channel Mode - Individual RGBA control

Channel	Name	DMX value	DMX percentage	Description	Info	Default DMX value	Fader type
1	RED	0 255	0% 100%	No RED >Maximum RED	Pixel 1	0 (0%)	Fade
2	GREEN	0 255	0% 100%	No GREEN > Maximum GREEN	Pixel 1		
3	BLUE	0 255	0% 100%	No BLUE > Maximum BLUE	Pixel 1		
4	AMBER	0 255	0% 100%	No AMBER > Maximum AMBER	Pixel 1		
5	RED	0 255	0% 100%	No RED > Maximum RED	Pixel 2		
6	GREEN	0 255	0% 100%	No GREEN > Maximum GREEN	Pixel 2		
7	BLUE	0 255	0% 100%	No BLUE > Maximum BLUE	Pixel 2		
8	AMBER	0 255	0% 100%	No AMBER > Maximum AMBER	Pixel 2		
9	RED	0 255	0% 100%	No RED >Maximum RED	Pixel 3		
10	GREEN	0 255	0% 100%	No GREEN > Maximum GREEN	Pixel 3		
11	BLUE	0 255	0% 100%	No BLUE > Maximum BLUE	Pixel 3		
12	AMBER	0 255	0% 100%	No AMBER >Maximum AMBER	Pixel 3		

Channel	Name	DMX value	DMX percentage	Description	Info	Default DMX value	Fader type
13	RED	0 255	0% 100%	No RED >Maximum RED	Pixel 4	0 (0%)	Fade
14	GREEN	0 255	0% 100%	No GREEN > Maximum GREEN	Pixel 4		
15	BLUE	0 255	0% 100%	No BLUE > Maximum BLUE	Pixel 4		
16	AMBER	0 255	0% 100%	No AMBER >Maximum AMBER	Pixel 4		
17	RED	0 255	0% 100%	No RED >Maximum RED	Pixel 5		
18	GREEN	0 255	0% 100%	No GREEN > Maximum GREEN	Pixel 5		
19	BLUE	0 255	0% 100%	No BLUE > Maximum BLUE	Pixel 5		
20	AMBER	0 255	0% 100%	No AMBER >Maximum AMBER	Pixel 5		
21	RED	0 255	0% 100%	No RED >Maximum RED	Pixel 6		
22	GREEN	0 255	0% 100%	No GREEN > Maximum GREEN	Pixel 6		
23	BLUE	0 255	0% 100%	No BLUE > Maximum BLUE	Pixel 6		
24	AMBER	0 255	0% 100%	No AMBER >Maximum AMBER	Pixel 6		

28 Channel Mode - Effects, Intensity, Halogen Dimmer Emulation & individual RGBA control

Channel	Name	DMX value		DMX percentage		Description	Info	Default DMX value	Fader type
1	Shutter	0	7	0,0%	2,7%	Closed		10 (3,9%)	Snap
		8	15	3,1%	5,9%	Open			
		16	151	6,3%	59,2%	Strobe	Fast > Slow		
		152	175	59,6%	68,6%	Pulse - Open	Slow > Fast		
		176	199	69,0%	78,0%	Pulse - Close	Slow > Fast		
		200	244	78,4%	95,7%	Strobe - Random	Slow > Fast		
		245	255	96,1%	100,0%	Open			
2	Intensity	0	255	0%	100%	No Light > Maximum light		0 (0%)	Fade

Channel	Name	DMX value		DMX percentage		Description	Info	Default DMX value	Fader type
3	Halogen Dimmer Emulation	0	7	0%	2,7%	Disable		0 (0%)	Fade
		8	15	3,1%	5,9%	Emulate Halogen dimming			
		16	255	6,3%	100%	No Function			
4	CTC	0	9	-	-	No function		0 (0%)	Fade
		10	255	0%	100%	Color Temperature (3200K-6500K)	Only when RGBA is at 100%		
5	RED	0	255	0%	100%	No RED >Maximum RED	Pixel 1		
6	GREEN	0	255	0%	100%	No GREEN > Maximum GREEN	Pixel 1		
7	BLUE	0	255	0%	100%	No BLUE > Maximum BLUE	Pixel 1		
8	AMBER	0	255	0%	100%	No AMBER >Maximum AMBER	Pixel 1		
9	RED	0	255	0%	100%	No RED >Maximum RED	Pixel 2		
10	GREEN	0	255	0%	100%	No GREEN > Maximum GREEN	Pixel 2		

Channel	Name	DMX value		DMX percentage		Description	Info	Default DMX value	Fader type
11	BLUE	0	255	0%	100%	No BLUE > Maximum BLUE	Pixel 2	0 (0%)	Fade
12	AMBER	0	255	0%	100%	No AMBER >Maximum AMBER	Pixel 2		
13	RED	0	255	0%	100%	No RED >Maximum RED	Pixel 3		
14	GREEN	0	255	0%	100%	No GREEN > Maximum GREEN	Pixel 3		
15	BLUE	0	255	0%	100%	No BLUE > Maximum BLUE	Pixel 3		
16	AMBER	0	255	0%	100%	No AMBER >Maximum AMBER	Pixel 3		
17	RED	0	255	0%	100%	No RED >Maximum RED	Pixel 4		
18	GREEN	0	255	0%	100%	No GREEN > Maximum GREEN	Pixel 4		
19	BLUE	0	255	0%	100%	No BLUE > Maximum BLUE	Pixel 4		
20	AMBER	0	255	0%	100%	No AMBER >Maximum AMBER	Pixel 4		
21	RED	0	255	0%	100%	No RED >Maximum RED	Pixel 5		
22	GREEN	0	255	0%	100%	No GREEN > Maximum GREEN	Pixel 5		
23	BLUE	0	255	0%	100%	No BLUE > Maximum BLUE	Pixel 5		

Channel	Name	DMX value		DMX percentage		Description	Info	Default DMX value	Fader type
24	AMBER	0	255	0%	100%	No AMBER >Maximum AMBER	Pixel 5	0 (0%)	Fade
25	RED	0	255	0%	100%	No RED >Maximum RED	Pixel 6		
26	GREEN	0	255	0%	100%	No GREEN > Maximum GREEN	Pixel 6		
27	BLUE	0	255	0%	100%	No BLUE > Maximum BLUE	Pixel 6		
28	AMBER	0	255	0%	100%	No AMBER >Maximum AMBER	Pixel 6		

48 Channel Mode - 8-bit/16-bit individual RGBA control

Channel	Name	DMX value	DMX percentage	Description	Info	DefaultDMX value	Fader type
1 2	RED	0 65535	0% 100%	No RED >Maximum RED	Pixel 1	0 (0%)	Fade
3 4	GREEN	0 65535	0% 100%	No GREEN > Maximum GREEN	Pixel 1		
5 6	BLUE	0 65535	0% 100%	No BLUE > Maximum BLUE	Pixel 1		
7 8	AMBER	0 65535	0% 100%	No AMBER >Maximum AMBER	Pixel 1		
9 10	RED	0 65535	0% 100%	No RED >Maximum RED	Pixel 2		
11 12	GREEN	0 65535	0% 100%	No GREEN > Maximum GREEN	Pixel 2		
13 14	BLUE	0 65535	0% 100%	No BLUE > Maximum BLUE	Pixel 2		

Channel	Name	DMX value	DMX percentage	Description	Info	Default DMX value	Fader type
15 16	AMBER	0 65535	0% 100%	No AMBER >Maximum AMBER	Pixel 2	0 (0%)	Fade
17 18	RED	0 65535	0% 100%	No RED >Maximum RED	Pixel 3		
19 20	GREEN	0 65535	0% 100%	No GREEN > Maximum GREEN	Pixel 3		
21 22	BLUE	0 65535	0% 100%	No BLUE > Maximum BLUE	Pixel 3		
23 24	AMBER	0 65535	0% 100%	No AMBER >Maximum AMBER	Pixel 3		
25 26	RED	0 65535	0% 100%	No RED >Maximum RED	Pixel 4		
27 28	GREEN	0 65535	0% 100%	No GREEN > Maximum GREEN	Pixel 4		
29 30	BLUE	0 65535	0% 100%	No BLUE > Maximum BLUE	Pixel 4		

Channel	Name	DMX value	DMX percentage	Description	Info	Default DMX value	Fader type
31 32	AMBER	0 65535	0% 100%	No AMBER >Maximum AMBER	Pixel 4	0 (0%)	Fade
33 34	RED	0 65535	0% 100%	No RED >Maximum RED	Pixel 5		
35 36	GREEN	0 65535	0% 100%	No GREEN > Maximum GREEN	Pixel 5		
37 38	BLUE	0 65535	0% 100%	No BLUE > Maximum BLUE	Pixel 5		
39 40	AMBER	0 65535	0% 100%	No AMBER >Maximum AMBER	Pixel 5		
41 42	RED	0 65535	0% 100%	No RED >Maximum RED	Pixel 6		
43 44	GREEN	0 65535	0% 100%	No GREEN > Maximum GREEN	Pixel 6		
45 46	BLUE	0 65535	0% 100%	No BLUE > Maximum BLUE	Pixel 6		

Channel	Name	DMX value	DMX percentage	Description	Info	Default DMX value	Fader type
47 48	AMBER	0 65535	0% 100%	No AMBER >Maximum AMBER	Pixel 6	0 (0%)	Fade

53 Channel Mode - Effects, Intensity, Halogen Dimmer Emulation & 8-bit/16-bit individual RGBA control

Channel	Name	DMX value		DMX percentage		Description	Info	Default DMX value	Fader type
1	Shutter	0	7	0,0%	2,7%	Closed		10 (3,9%)	Snap
		8	15	3,1%	5,9%	Open			
		16	151	6,3%	59,2%	Strobe	Fast > Slow		
		152	175	59,6%	68,6%	Pulse - Open	Slow > Fast		
		176	199	69,0%	78,0%	Pulse - Close	Slow > Fast		
		200	244	78,4%	95,7%	Strobe - Random	Slow > Fast		
		245	255	96,1%	100,0%	Open			
2 3	Intensity	0	65535	0%	100%	No Light > Maximum light		0 (0%)	Fade

Channel	Name	DMX value		DMX percentage		Description	Info	Default DMX value	Fader type
4	Halogen Dimmer Emulation	0	7	0%	2,7%	No Function		0 (0%)	Fade
		8	15	3,1%	5,9%	Emulate Halogen dimming characteristics			
		16	21	6,3%	8,2%	Emulate Halogen dimming instant attack			
		22	255	8,6%	100%	No Function			
5	CTC	0	255	0%	100%	Color Temperature (3200K-6500K)	Only when RGBA is at 100%	0 (0%)	Fade
6 7	RED	0	65535	0%	100%	No RED >Maximum RED	Pixel 1		
8 9	GREEN	0	65535	0%	100%	No GREEN > Maximum GREEN	Pixel 1		

Channel	Name	DMX value		DMX percentage		Description	Info	Default DMX value	Fader type
10 11	BLUE	0	65535	0%	100%	No BLUE > Maximum BLUE	Pixel 1	0 (0%)	Fade
12 13	AMBER	0	65535	0%	100%	No AMBER >Maximum AMBER	Pixel 1		
14 15	RED	0	65535	0%	100%	No RED >Maximum RED	Pixel 2		
16 17	GREEN	0	65535	0%	100%	No GREEN > Maximum GREEN	Pixel 2		
18 19	BLUE	0	65535	0%	100%	No BLUE > Maximum BLUE	Pixel 2		
20 21	AMBER	0	65535	0%	100%	No AMBER >Maximum AMBER	Pixel 2		
22 23	RED	0	65535	0%	100%	No RED >Maximum RED	Pixel 3		

Channel	Name	DMX value		DMX percentage		Description	Info	Default DMX value	Fader type
24 25	GREEN	0	65535	0%	100%	No GREEN > Maximum GREEN	Pixel 3	0 (0%)	Fade
26 27	BLUE	0	65535	0%	100%	No BLUE > Maximum BLUE	Pixel 3		
28 29	AMBER	0	65535	0%	100%	No AMBER >Maximum AMBER	Pixel 3		
30 31	RED	0	65535	0%	100%	No RED >Maximum RED	Pixel 4		
32 33	GREEN	0	65535	0%	100%	No GREEN > Maximum GREEN	Pixel 4		
34 35	BLUE	0	65535	0%	100%	No BLUE > Maximum BLUE	Pixel 4		
36 37	AMBER	0	65535	0%	100%	No AMBER >Maximum AMBER	Pixel 4		

Channel	Name	DMX value	DMX percentage	Description	Info	Default DMX value	Fader type
38 39	RED	0 65535	0% 100%	No RED >Maximum RED	Pixel 5	0 (0%)	Fade
40 41	GREEN	0 65535	0% 100%	No GREEN > Maximum GREEN	Pixel 5		
42 43	BLUE	0 65535	0% 100%	No BLUE > Maximum BLUE	Pixel 5		
44 45	AMBER	0 65535	0% 100%	No AMBER >Maximum AMBER	Pixel 5		
46 47	RED	0 65535	0% 100%	No RED >Maximum RED	Pixel 6		
48 49	GREEN	0 65535	0% 100%	No GREEN > Maximum GREEN	Pixel 6		
50 51	BLUE	0 65535	0% 100%	No BLUE > Maximum BLUE	Pixel 6		
52 53	AMBER	0 65535	0% 100%	No AMBER >Maximum AMBER	Pixel 6		

Control menu

Level 1	Level 2	Level 3	Function
MODE	SELECT MODE	-	Select DMX mode. See “Setting the DMX mode” on page 30 for information about the features of each mode.
INFO	FIRMWARE VERSION	-	Displays installed software version.
	SERIAL NUMBER	-	Displays serial number.
	RDM ID	-	Displays RDM ID (for use with the SGM Tool App).
	DMX VIEW	-	Displays received DMX levels.
	TEMPERATURES	-	Displays fixture temperatures (MB, LEFT, RIGHT)
	RUNNING HOURS	-	Displays the fixture’s running hours.
	LOG	-	Displays recorded operating data and error codes.

Level 1	Level 2	Level 3	Function
SETTINGS	REVERSE PIXEL ORDER	NORMAL	-
		REVERSED	Pixel order for DMX control is reversed. See “Planning the layout of fixtures in an array” on page 16.
	STARTUP MODE	SELECT STARTUP MODE	Default operating mode when fixture is powered on: 1. Quick Color 2. Stand-alone 3. DMX (factory default)
		STARTUP PROGRAM	Stand-alone program 1, 2, or 3. Only used if the startup mode is set to “stand-alone”. 1 is default.
	DIMMING CURVE	LINEAR	Provides equal resolution dimming from 0-100%.
		GAMMA CORRECTED	Provides high-resolution dimming at low levels.
	FLIP DISPLAY	DISABLE	Selects normal control panel display.
		ENABLE	Flips control panel display.

Level 1	Level 2	Level 3	Function
SETTINGS (continued)	DISPLAY SAVER	DISPLAY DIM	Dims the OLED display when the control panel is not in use.
		DISPLAY OFF	Turns off the OLED display when the control panel is not in use.
	TEMPERATURE DIM MODE	STANDARD	The colors dim in relation to the temperature of the fixture, to keep the color output constant.
		MAX POWER	The output is not adjusted in relation to the temperature of the fixture.
	FACTORY DEFAULT	-	Reset the fixture to factory default settings.

Level 1	Level 2	Level 3	Function
MANUAL	QUICK COLOR	RED	Static quick color - red mix (0-255). Sets fixture to quick color startup mode.
		GREEN	Static quick color - green mix (0-255). Sets fixture to quick color startup mode.
		BLUE	Static quick color - blue mix (0-255). Sets fixture to quick color startup mode.
		AMBER	Static quick color - white mix (0-255). Sets fixture to quick color startup mode.
	RUN PROGRAM	1, 2, or 3	
	STOP PROGRAM	-	
	EDITOR	PROGRAM	Currently selected program (1, 2, or 3).

Level 1	Level 2	Level 3	Function
MANUAL (continued)	EDITOR (continued)	SCENE	Currently selected scene (1-24).
		RED	Red value in currently selected scene (0-255).
		GREEN	Green value in currently selected scene (0-255).
		BLUE	Blue value in currently selected scene (0-255).
		WHITE	White value in currently selected scene (0-255).
		SHUTTER	Shutter setting in currently selected scene (0-255):
			Shutter Blackout (0-7)
			Shutter Open (8-15)
			Variable Strobe (16-151)
			Pulse Open (152-175)
			Pulse Close (176-199)
			Variable Random Strobe (200-244)
		Shutter Open (245-255)	

Level 1	Level 2	Level 3	Function
MANUAL (continued)	EDITOR (continued)	FADE TIME (MIN.)	Fade-in (transition) time to current scene in min. (0-999).
		FADE TIME (SEC.)	Fade-in (transition) time to current scene in sec. (0-59).
		WAIT TIME (MIN.)	Wait (static) time in current scene in min. (0-999).
		WAIT TIME (SEC.)	Wait (static) time in current scene in sec. (0-59).
TEST	OFF	-	Stops self-test sequence
	AUTOMATED TEST	-	Executes a self-test sequence
	BURN-IN TEST 30 MIN.	-	Service use only.
	DISPLAY TEST	-	Service use only.

Fixtures and accessories

Included items

User manual

U-bracket

Vertical mounting bracket

2 m power cable with Neutrik TRUE1

Ordering information

SixPack	Order no: 80030505
SixPack horizontal bracket	Order no: 83060606
SixPack hanger bracket set.....	Order no: 83060611
2 m power cable with Neutrik TRUE1	Order no: 07860040
SGM USB uploader cable	Order no: 83062011

APPROVALS AND CERTIFICATIONS

Certified to CSA Std. C22.2 No. 166
Conforms to UL Std. 1573
Conforms to 2006/95/EC: Low Voltage Directive
Conforms to 2004/108/EC: EMC Directive
Conforms to 2011/65/EU: RoHS2 Directive



The information in this document is subject to change without notice

User's notes



SGM A/S · Sommervej 23 · 8210 Aarhus V · Denmark
Tel +45 70 20 74 00 · info@sgmlight.com · www.sgmlight.com